

# **KING-METER**



## **USER GUIDE**

---

## **SW-LCD**

# Contents

<b>1. Preface .....</b>	<b>19</b>
<b>2. Appearance and Size.....</b>	<b>20</b>
2.1 Material and Color.....	20
2.2 Display Size and Installation Size .....	20
<b>3. Function Summary and Button Definition...21</b>	
3.1 Preset and Default Items .....	21
3.2 Display Figures .....	21
3.3 Button Definition.....	22
<b>4. Installation Instruction.....</b>	<b>23</b>
<b>5. Set up .....</b>	<b>23</b>
5.1 Preparation before Starting the Display.....	23
5.2 Start and Entry Setting State.....	23
5.3 Wheel Diameter.....	23
5.4 Max Speed.....	24
5.5 Backlight Brightness.....	24
5.6 Choice of Display Unit... ..	25
5.7 Quit from Set up.....	26
<b>6. Standard operation.....</b>	<b>26</b>
6.1 Power ON / OFF.....	26
6.2 Power Display.....	26
6.3 Assisted Power Select or Throttle Level Select .....	27
6.4 Distance Display .....	28
6.5 Push cruise control.....	28
6.6 Turn On and Turn Off the Backlight.....	29

6.7 Power of the Display.....	29
6.8 Error Code Display.....	30
<b>7. Attention for Using.....</b>	<b>31</b>
<b>8. FAQ Answers.....</b>	<b>31</b>
<b>9. Quality Warranty and Coverage.....</b>	<b>32</b>
<b>10. Circuit Block Diagram.....</b>	<b>32</b>
<b>11. Software Version .....</b>	<b>32</b>

## 1、Preface

Dear users,

To ensure better performance of your e-bike, please read through the SW-LCD product introduction carefully before using it. We will use the brief words to inform you of all the details (including hardware installation, setting and normal use of the display) when using our display. Meanwhile, the introduction will also help you solve possible confusion and barriers.

## 2、 Appearance and Size

### 2.1 Material and Color

SW-LCD housing material: PC. And the color of housing is white or black. Working temperature scope:  $-20^{\circ}\text{C}$ — $+60^{\circ}\text{C}$ , the shell material can ensure normal use and good mechanical performance of the products.

### 2.2 Display Size and Installation Size (Unit: mm)

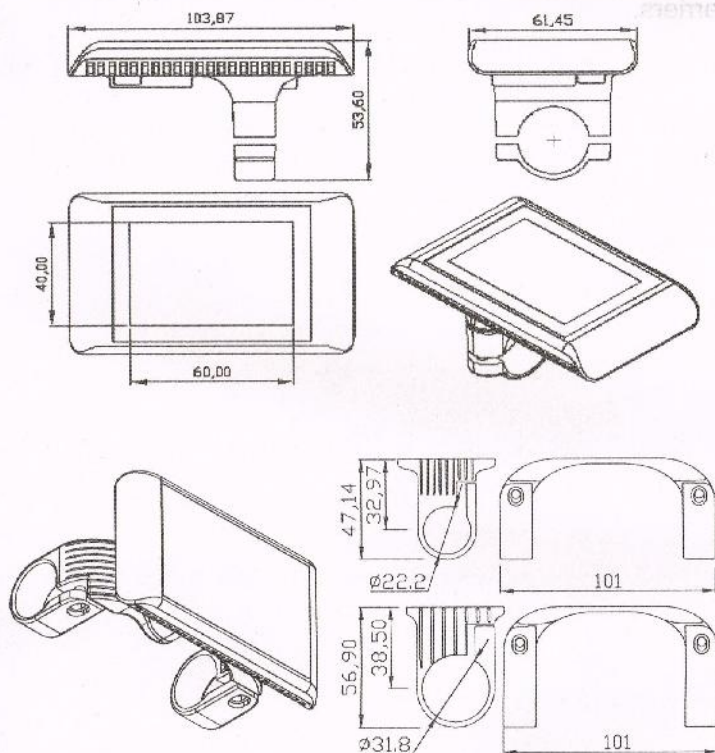

### 3、 Function Summary and Button Definition

#### 3.1 Preset and Default Items

SW-LCD user settings include: wheel diameter (18-28inch) ; max speed; LCD backlight contrast; choice of display unit.

#### 3.2 Display Figures:

Display content: battery capacity, motor power ratio, riding speed, riding distance, power, PUSH cruise control, and error code display of the electronic control system.



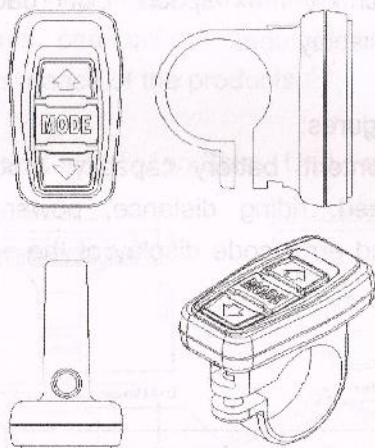

### 3.3 Button Definition

SW-LCD is equipped with special 30-button unit. This operating button is suit for both L/R hand, button instruction figures as follows:



30-button unit is connected to the bottom of the SW-LCD display via lead cable.

In the following introduction,  is named as

“MODE”.  is named as “UP” and  is named as “DOWN”.

## 4. Installation Instruction

Fix the display and 30-button unit on the handlebar and adjust to an appropriate visual angle. Match display connector with controller connector.

## 5. Set up

### 5.1 Preparation for Starting the Display

Make sure connector linked properly to the motor controller on the bike.

### 5.2 Start and Entry Setting State

Press the **MODE** button for 1.5 seconds and start the display.

After start-up, please hold both **UP** and **DOWN** for 2.5 seconds at the same time, LCD will enter into the setting state, and the settable parameter will flash. The parameter can be set circularly.

### 5.3 Wheel Diameter

The first setting parameter is wheel diameter. The interface is as follows:



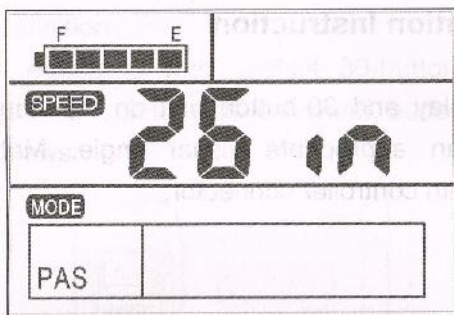

Press **UP** or **DOWN** to choose a right diameter (18-28inch) for the bike. Default set is 26 inch. After confirmation of wheel size, press **MODE** to reserve it and enter into the max speed set.

#### 5.4 Max Speed

The second setting parameter is Max Speed. The interface is as below:

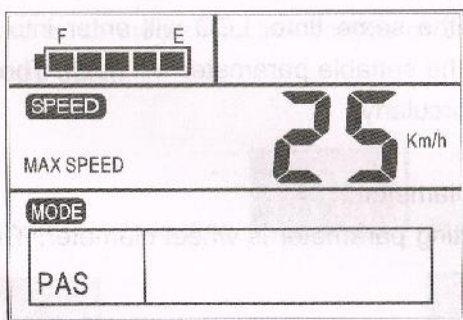

Re-set speed should be in accordance with the local regulation speed. If exceed your re-set figure, the bike will travel at the max speed of reset. Default max speed in

factory is 25 Km/h.

Speed option: 12-40Km/h, use **UP** or **DOWN** then confirm by **MODE**. Then enter into the interface of backlight brightness.

### 5.5 Backlight Brightness

The third setting parameter is backlight brightness. The interface is as below:

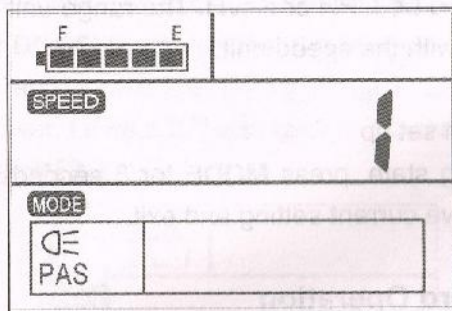

Press **UP** or **DOWN** to modify the backlight brightness. You can choose from level 1 to level 3. Level 1 is the minimum brightness. Level 3 is the maximum brightness. The default value of the backlight brightness is level 1. Press the **MODE** to confirm the backlight brightness, then entry into the interface of Choice of Display Unit.

### 5.6 Choice of Display Unit (Metric system / British system)

The fourth setting parameter is Choice of Display Unit. The interface is as below:

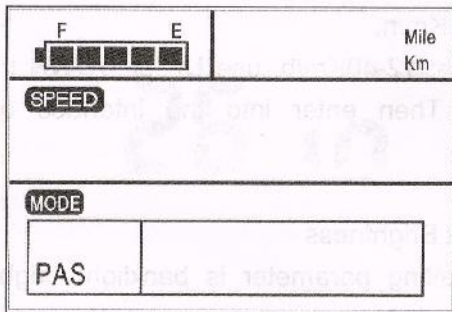

Press **UP** or **DOWN** to choose a display unit.

The unit could be MPH or Km/H. The range unit will change accordingly with the speed unit.

### 5.7 Quit from set up

In the setting state, press **MODE** for 3 seconds to confirm the input, save current setting and exit.

## 6. Standard Operation

### 6.1 ON / OFF

Press **MODE**, then the display starts to work and supply power to controller, long press **MODE** then switch off power. In the status of OFF, display and controller no longer consume battery power.

### 6.2 Capacity Display

When the battery capacity is high, the five battery segments are all light. When the battery is in low voltage, the last

battery segment will flash at 1 Hz. It indicates that the battery is severely low in voltage condition and needs to be recharged immediately.

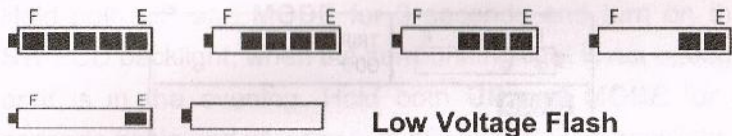

### 6.3 Assisted Power Select or Throttle Level Select

Press **UP** or **DOWN** to change the output power of the motor. The power ranges from Level 1 to Level 5. Level 1 is the minimum power. Level 5 is the maximum power. The default level is Level 1.

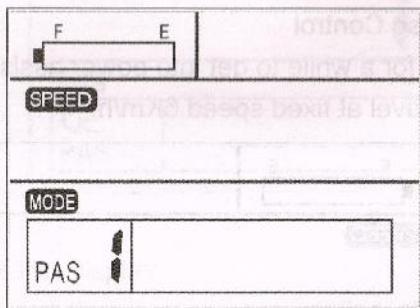

The choice of motor power rate

#### 6.4 Distance Display (Riding Distance / Total Distance)

Press **MODE** to switch between riding distance and total distance. This function is convenient for users to check the riding distance (TRIP) and the total distance (ODO).

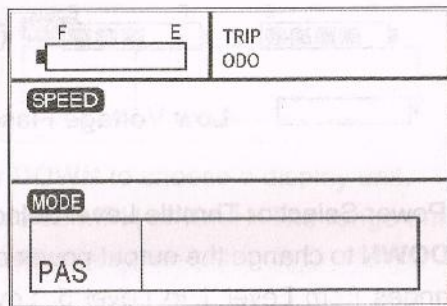

Range Interface

#### 6.5 Push Cruise Control

Press **DOWN** for a while to get into power assist mode, and the bike will travel at fixed speed 6Km/h.

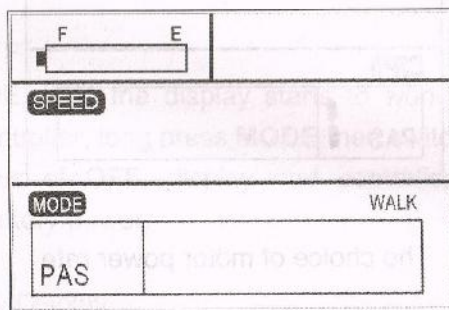

Interface of power assist walk

**Warning : Push cruise control mode is recommended under push state, not for riding mode.**

### 6.6 Turn On and Turn Off the Backlight

Hold both **UP** and **MODE** for 3 seconds and turn on the SW-LCD backlight, when the surrounding light is not enough or it is in the evening. Hold both **UP** and **MODE** for 3 seconds again and you can turn off the SW-LCD backlight. When the backlight power ON, the headlight also power on (if the bike assembles with a headlight). And the function could be customized.

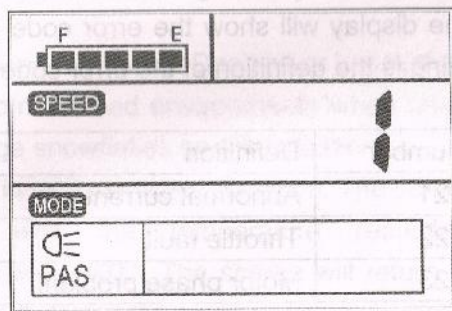

### 6.7 Power of the Display

Display the real time power consumption of the riding for electric bike. The interface below:

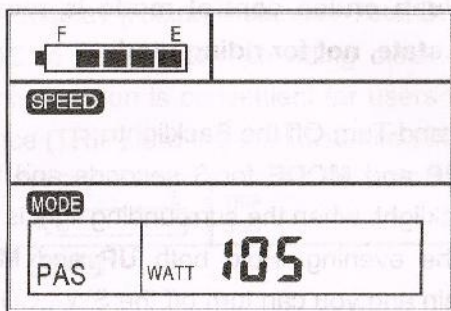

### 6.8 Error Code Display

If there is something wrong with the electronic control system, the display will show the error code automatically. The following is the definition of the error code.

Code number	Definition
21	Abnormal current
22	Throttle fault
23	Motor phase problem
24	Motor Hall defect
25	Brake failed

Definition Diagram of Error Codes

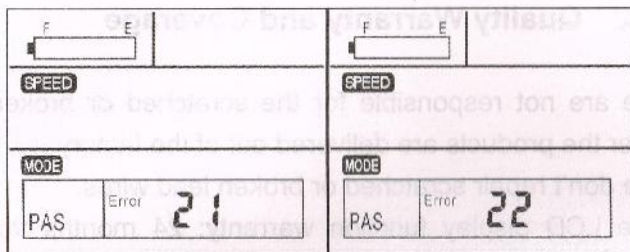

Error Code Display

Display return to normal only after problem being fixed and bike will not run before fixing the problem.

## 7、 Attention for Using

Ride your bike in a safe way. Don't hit or knock the display. Keep away from the bad environments when use, such as downpour, large snowflakes and solarization.

Try not to use in under-voltage condition. The screen will get dark along with the temperature reduction when temperature below  $-10^{\circ}\text{C}$ . The screen will return to normal when the temperature rises again.

## 8、 FAQ Answers

Q: Why can't turn on the display?

A: Please check if the cable is well connected with the controller.

Q: How to deal with the error code display?

A: Contact the e-bike maintenance station in time.



## 9、 Quality Warranty and Coverage

We are not responsible for the scratched or broken shell after the products are delivered out of the factory.

We don't repair scratched or broken lead wires.

The LCD display function warranty: 24 months from the delivery time of the display out of the factory.

## 10、 Circuit Block Diagram

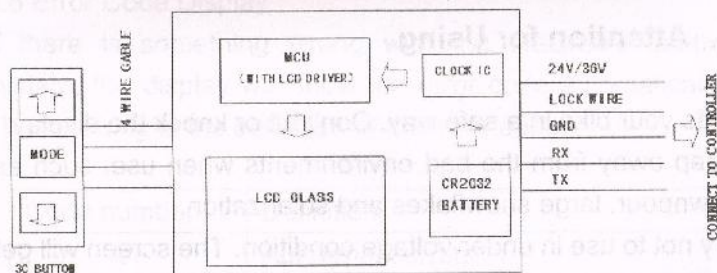

Red: 24V/36V; Blue: lock wire; Black: GND; Green/ Yellow: RX / TX wire.

Due to the use of the waterproof connector of part products, users cannot see the leads color of the internal wiring.

## 11、 Software Version

This operating instruction is a general-purpose software (version V2.0). Some of the version of the e-bike LCD may have slightly difference, all with actual use version.

***KING-METER***